

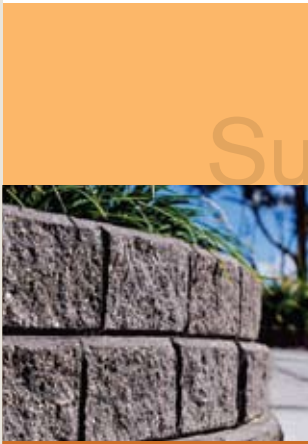

**Sunway Paving
Solutions Sdn Bhd**
77490-W

Sunway Split Face Bricks
Sunway Fluted Concrete Blocks

Sunway Lock Stone & Cap Units



Decorative
Concrete Masonry Units
and Hollow Concrete Blocks

Sunway Lock Stone & Cap Units
Sunway Fluted Concrete Blocks

Authorized Distributor
BA Contracts Pte Ltd
Add: 48 Toh Guan Road East, #03-129, Enterprise Hub, Singapore 608586
Tel: +65 6842 2239
Fax: +65 6848 1229
Email: hello@bac.com.sg

Consistent Quality Our Priority



Sunway Paving Solutions Sdn Bhd

77490-W

Building Confidence In Concrete Block Technology

Decorative Concrete Masonry Units (CMUs)

Sunway Paving Solutions Sdn.Bhd. (SPS)'s Decorative CMUs smile on the world with all the charm born of confidence in their good looks, variety of colors and their immediate and almost irresistible appeal to the layman, architect and decorator alike.

Hollow Concrete Blocks

SPS's Hollow Concrete Blocks are a perfectly calibrated blend of cement and graded coarse and fine aggregates. Each block processes superior quality and uniformity in dimensions and strength.

Meeting The Highest Standard

Manufactured and approved in compliance to Malaysian and British Standards, and widely accepted by local authorities, SPS's Decorative CMUs and Hollow Concrete Blocks are noted for their aesthetic beauty, superior structural, noise reduction and fire resistance properties.

Firm Corporate Support

With firm corporate support from the Sunway Group, SPS draws its vast expertise and resources to offer the most comprehensive and consistent service and quality achievable. This commitment to success has made SPS one of Malaysia's largest producers of Decorative CMUs and Hollow Concrete Blocks.



Sunway Split Face Bricks

Highly compacted concrete blocks, which are splitted during the production into two (2) later, the split face technique has two (2) main steps, i.e. forming & splitting. When the block is split, the internal aggregates are exposed and the natural lines of these aggregates offer a rough finish / texture that is appealing, where a natural look is desired. It act as an attractive alternative to plain concrete blocks, Split Face Bricks mimic the design of Romanosque architecture. It can create artistic representations in the form of simple geometric renderings when installed. The topographical appearance of the Split Face Bricks allows the shadow on a building to create a changing visual, as the sun moves through out the day. The bricks can be installed quickly and are supplied in a variety of color tones.



Characteristic of Split Face Bricks

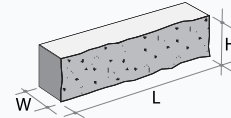

Dimension	: 100mm(W) x 80mm(H) x 200mm(L)
Brick Thickness	: 80mm
Weight	: 3.3 kg - 3.5 kg
Compressive Strength	: 3000 psi

Water Absorption	: Below 8%
Test Methods	: According to ASTM C140
Tolerance	: Overall dimensions shall differ by ± 3 mm : On faces that are split, dimension shall differ by ± 8 mm from standard dimension.

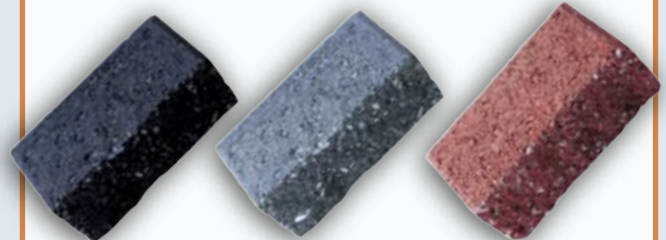

Black color

Grey color

Red color

Applications:

- Internal & External decorative wall of residential & commercial buildings
- Garden surround / landscaping
- Retaining walls (low height & non load-bearing)
- Garden planter boxes
- Perimeter fencing of residential houses

Efflorescence:

This superficial phenomenon is commonly found in most concrete-based or cementitious products. However, this efflorescence effect will disappear overtime (weathering) whereby rain usually washes the efflorescence away in about six months to a year and in the worst scenario could take two years.

Sunway Lock Stone & Cap Units

Highly compacted concrete blocks & cap units, with rough finish or texture similar to quarried stone. It has a rugged rocky texture that is appealing, where a natural look is desired. It act as an alternative to plain concrete blocks.

- Self-sloping and self-aligning with interlocking system
- Does not require structural foundations and mortarless
- Completed installation is virtually maintenance free
- Can be easily laid dry and self-draining
- Available in an assortment of colors and no painting required



Characteristic of Lock Stone & Cap Units

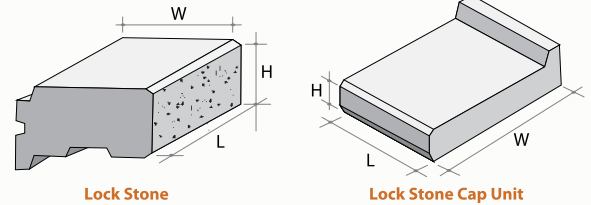

Dimension (**Lock Stone**) : 300mm(W) x 220mm(L) x 150mm(H)
 Block Thickness : 150mm
 Weight : 22 kg
 Compressive Strength : 2000 psi

Dimension (**Cap Unit**) : 300mm(W) x 220mm(L) x 60mm(H)
 Block Thickness : 60mm
 Weight : 10.3 kg
 Compressive Strength : 2000 psi

Water Absorption : Below 8%
 Test Methods : According to ASTM C140
 Tolerance : Overall height dimensions shall differ by ± 3 mm
 : On rough finish / rugged texture, dimension shall differ by ± 8 mm from standard dimension.

Applications:

- External decorative wall (low height & non load-bearing)
- Garden surround / landscaping
- Garden planter boxes
- Perimeter fencing of residential house



Efflorescence:

This superficial phenomenon is commonly found in most concrete-based or cementitious products. However, this efflorescence effect will disappear overtime (weathering) whereby rain usually washes the efflorescence away in about six months to a year and in the worst scenario could take two years.

Sunway Fluted Concrete Blocks

Fluted Concrete Blocks are normally used to enhance the exterior or sometimes the interior, with its preformed vertical lines. The ribs of fluted blocks protrude from the wall surface and these ribs can be aligned during installation to form a continuous vertical ribs throughout the height of the structure / building. This protrude ribs creates a shadowing effect on the wall surface. It is structurally strong for load-bearing construction (LBC), easy to handle and lay, an economical alternative to reinforced concrete frame. It is a combination of stylish durability and state-of-art processing methods.



Characteristic of Fluted Concrete Blocks

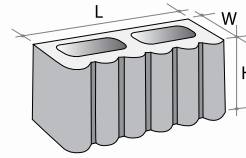

Fluted Standard Unit

140mm(W) X 190mm(H) x 390mm(L)

190mm(W) X 190mm(H) x 390mm(L)

* Fluted Half Concrete Blocks are available upon request.

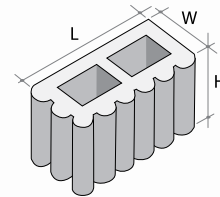

Fluted Corner Standard Unit

190mm(W) X 190mm(H) x 390mm(L)

* Fluted Corner Half Concrete Blocks are available upon request.

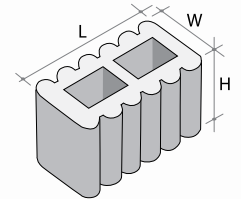

Double Fluted Standard Unit

190mm(W) X 190mm(H) x 390mm(L)

Compressive Strength	: minimum 7 Mpa
Drying Shrinkage	: not exceeding 0.06%
Dimension Tolerance	: Length \pm 2mm
	: Height - 5mm + 3mm
	: Thickness + 2mm - 2mm
Manufactured in accordance	: with BS 6073 : Part 1

Applications:

- Internal & External decorative wall of residential & commercial buildings
- Perimeter fencing of residential house
- Perimeter wall of warehouse / factory

Sunway Hollow Concrete Blocks

Generally, Hollow Concrete Blocks can be used for any applications that were typically made of bricks. It can be used for retaining wall, perimeter fencing, landscaping, as well as for buildings and structural elements.

Some of the advantages include light weight, good strength due to well mixed concrete and well compaction. It is cost effective, easy to install and it can be non-load bearing as well as load-bearing. The typical grey color of blocks is aesthetic and other colors can be produced by integrally adding color pigments.



Characteristic of Hollow Concrete Blocks

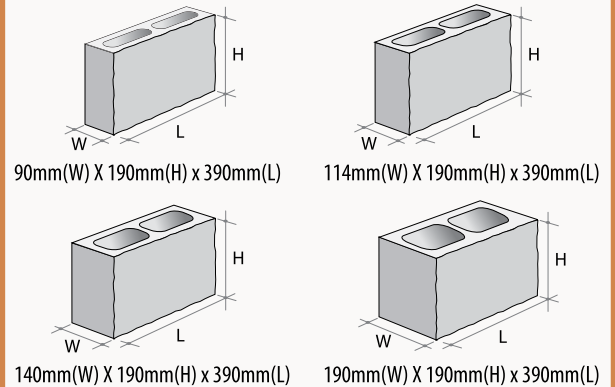

* Half Blocks for all series above are available upon request.

Compressive Strength	: minimum 7 Mpa
Drying Shrinkage	: not exceeding 0.06%
Dimension Tolerance	: Length \pm 2mm
	: Height - 5mm + 3mm
	: Thickness +2mm - 2mm
Fire Rated	: BS 476 : Part 22 : 1987
	: 90mm - 1 Hr
	: 140mm - 2 Hrs
Manufactured in accordance	: with BS 6073 : Part 1

Applications:

- Internal & External wall of residential & commercial buildings
- Perimeter fencing of residential houses
- Perimeter wall of warehouse / factory



**BUILDING
MATERIALS**

E-mail: spssales@sunway.com.my

Facebook: Sunway Paving Solutions Sdn. Bhd.

HQ Sales & Marketing Office

#3.2, Level 3, Menara Sunway,
Jalan Lagoon Timur, Bandar Sunway,
46150 Petaling Jaya,
Selangor Darul Ehsan, Malaysia.
Tel: (603) 5639 8282
Fax: (603) 5639 9600, 5639 9606

Factory: Batang Kali

Lot 10071, Mukim Batang Kali,
44300 Daerah Ulu Selangor,
Selangor Darul Ehsan,
Malaysia.
Tel: (603) 6057 2407
Fax: (603) 6057 2423

Northern Region Sales & Marketing Office/ Plant: Nibong Tebal Plant

Lot 2788, 2796, 2797,
Kawasan Perindustrian Bukit Panchor,
Mukim 7, Nibong Tebal, Seberang Perai Selatan,
14300 Pulau Penang, Malaysia.
Tel: (604) 593 8697/ 8
Fax: (604) 593 8695

Southern Region Sales & Marketing Office/ Plant: Senai Plant

PLO 6, Jalan Lapangan Terbang, Fasa 1,
Kawasan Perindustrian Senai, 81400 Senai,
Johor, Malaysia.
Tel: (607) 599 5553
Fax: (607) 599 3827



Buatan Malaysia

SIRIM
TESTED PAVING SLABS